



- 3 cylinders
- 1649 cm³
- 29,5 kW/40,1 HP
- 3000 r.p.m.
- Nm 113,0@1600

Available omologation

- EPA Interim TIER IV 
- 2004/26/CE Stage 3A 
- ECE R 24 

Construction

- 4-stroke diesel engine with cylinders in line
- Fluid-cooled with axial fan.
- Indirect injection.
- Single-shaft distribution with rod, valve levers and hydraulic tappets.
- Geared distribution control.
- Double pto on the crankshaft.
- Two pto on the distribution.
- Counterclockwise, rotation (1° PTO).
- Forced lubrication with vane pump on the crankshaft.
- Total passage external oil filter.
- Positionable fan and water pump.
- Automatic extra fuel starting device.
- Centrifugal governor.
- Torque regulator.
- Cast iron engine block with re-borable integral liners.
- Cast iron cylinder head.



Applications

- Mini excavator
- Fork lift
- Wood chipper
- Dumper
- Gen set
- Aerial platform
- Compressor
- High pressure cleaner
- Sweeper
- Pump
- Tractor

Specifications

Cylinders	N.	3
Displacement	cm ³	1649
Bore	mm	88
Stroke	mm	90,4
Compression ratio		22:1
Rating kW/HP	N (80/1269/CEE) ISO 1585	29,5/40,1
	NB ISO 3046 IFN	27,6/37,5
	NA ISO 3046 ICXN	25,4/34,5
Max. torque	Nm	106,5@1600
Max. torque 3 PT.O.	Nm	39,2@3000
Min. idling speed		900
Water pump delivery at 3000 r.p.m.	l/min.	75
Oil consumption	kg/h.	0,019
Oil sump capacity	l	3,8
Max. allowable inclination for:		
- short periods of operation (max. time 30 minutes)		25°
- peak values (max. time 1 minute)		35°
Cap. of air required for correct combustion @ 3000 r.p.m.	l/min.	2475
Cap. of air required for correct cooling @ 3000 r.p.m.	m ³ /min.	96
Dry weight	kg	156
Recommended battery	V/Ah	12/88

Minimum pulley diameters for belt drive

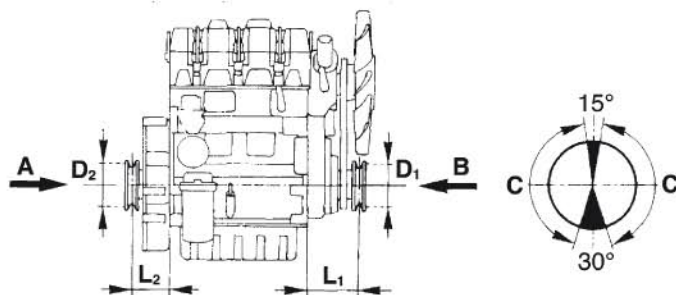

V belt	$D_2 \text{ (mm)} \geq 76 [L_2 \text{ (mm)} + 118]$	$\frac{N \text{ (kW)}}{n \text{ (RPM)}}$
--------	---	--

Cogged belt	$D_1 \text{ (mm)} \geq 49 [L_1 \text{ (mm)} + 118]$	$\frac{N \text{ (kW)}}{n \text{ (RPM)}}$
-------------	---	--

Max. intermittent axial load in both directions A-B = 300 kg
C - zone in which the radial load acts on the pulley

HOMOLOGATIONS EPA Interim TIER IV e 2004/26/CE Stage 3A ◆ ◆

Rating kW @ 3000 rpm	ISO 14396	29,0
Max. torque	Nm	104,0@1650

HOMOLOGATION ECE R24 ▲

Rating kW @ 3000 rpm	ISO 14396	27,6
Max. torque	Nm	103,0@1650

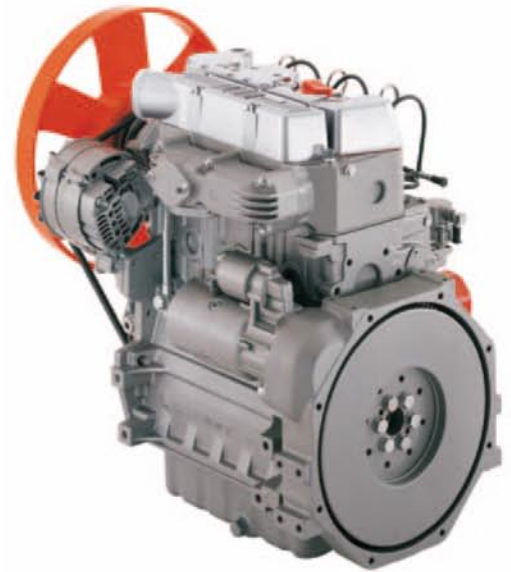

Sound pressure level dB (A)

Sound level polar diagram open field - 7 meters microphone - no load running engine.

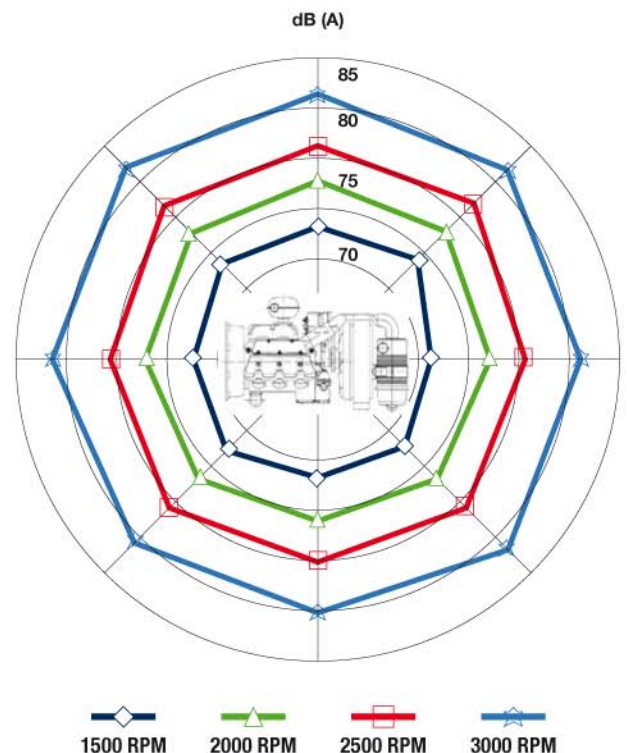

Curves

LDW 1603 @ 3000 r.p.m.

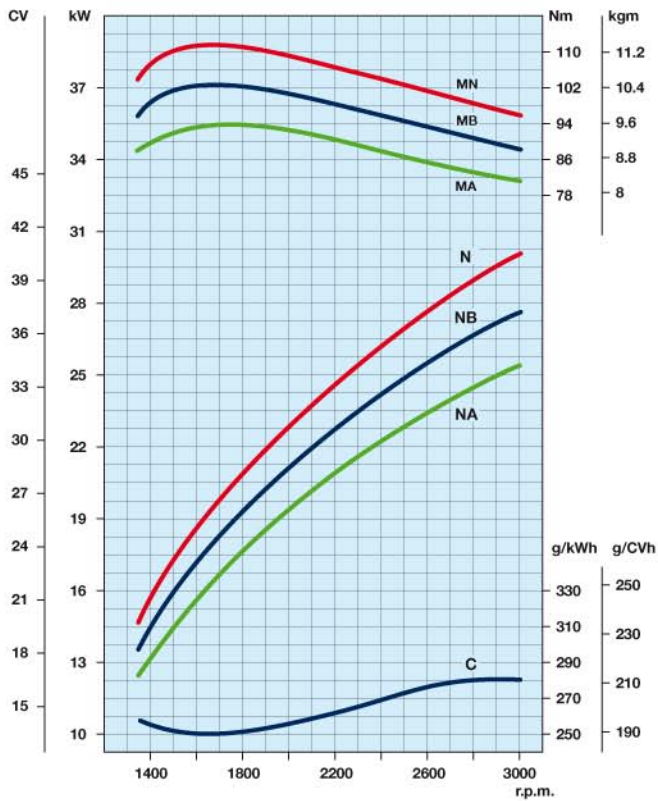

LDW 1603 B1 @ 2800 r.p.m. ▲

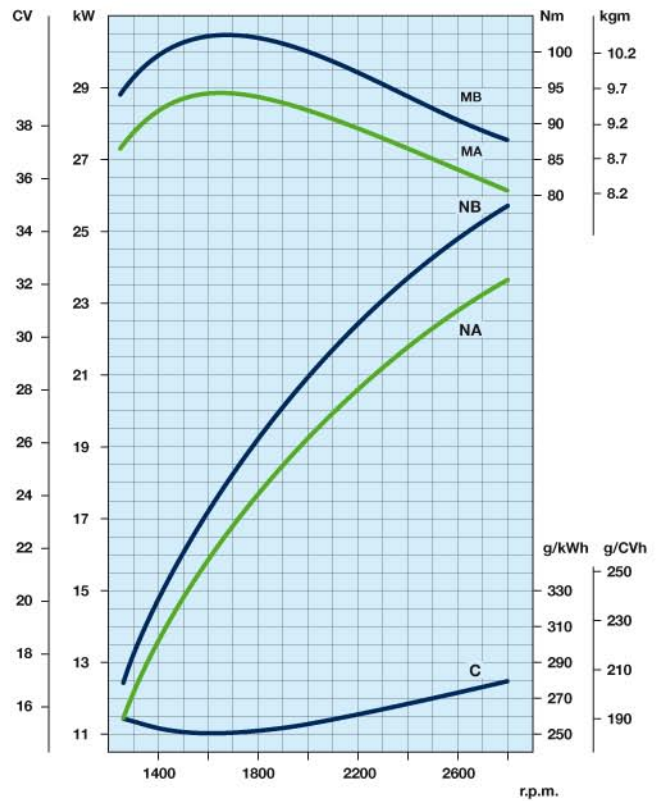

LDW 1603 B2 @ 2600 r.p.m. ▲

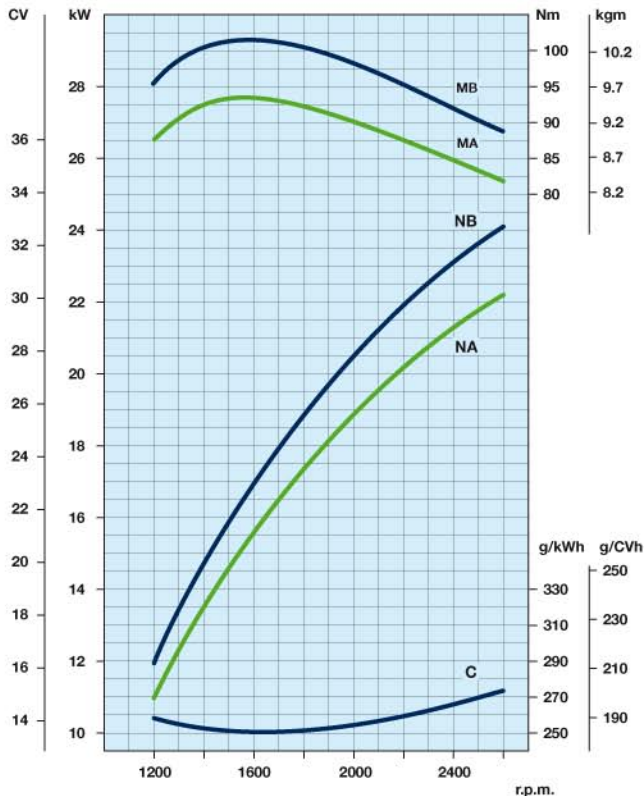

N Power curve - 80/1269/CEE - ISO 1585 -

NB Power curve - ISO 3046 - IFN -

NA Power curve - ISO 3046 - ICXN -

MN Torque curve - (N curve)

MB (NB curve) - MA (NA curve)

C Specific fuel consumption - (NB curve)

Power ratings refer to engines equipped with air filter, standard muffler, after being run in and in ambient conditions of 20°C and 1 bar. Power levels drop by 1% every 100m altitude and by 2% every 5°C above 20°C.

Output power for fixed speed application (including generating sets)

Engine power kW

r.p.m.	Intermittent (NB)	Continuous (NA)
3000	26,7	24,3
1800	18,5	16,8
1500	15,5	14,0

Technical drawings *

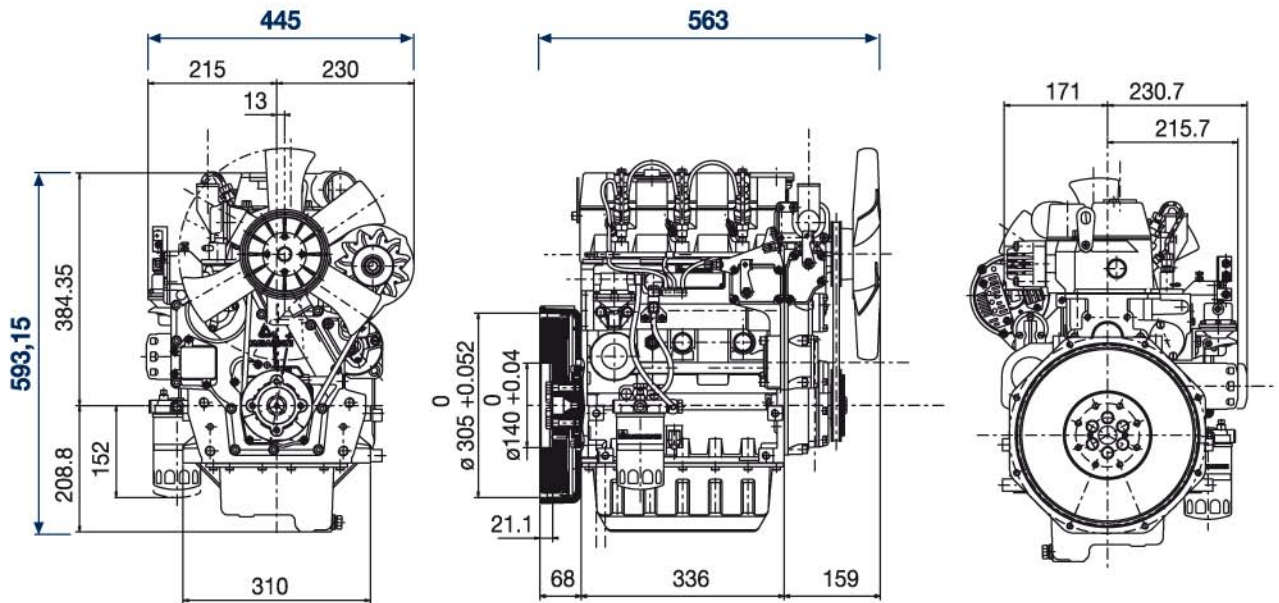

* More specific dimensions are available on www.lombardini.it (see table at the bottom of the page)

Standard equipment

- External oil filter
- Intake manifold
- Exhaust manifold
- Intake fan
- Accelerator control
- Electric starter and 12V alternator
- Thermostatic valve
- Fuel feed diaphragm pump
- Water pump
- Flanging plate
- Flywheel with ring gear
- Use, maintenance and spare parts booklet

Accessories

- Different guards according to use
- Clutches
- Clutch flywheels
- Flanges
- Hydraulic pump adaptors
- Keyswitch panel
- Electric stop
- Electronic plant for plugs
- Alternators
- Radiators
- Blowing fan
- Engine feet
- Fuel tanks
- Mufflers
- Dry air-cleaners mounted and separated
- Cyclonic precleaners
- Fuel filter on engine
- Cab heating system
- High capacity oil sump



ISO 9001 Cert. n. 0446 - 1405
QS. 9000 Cert. n. 2231/0



LOMBARDINI S.r.l. a Socio unico
Cap. Soc. € 44.000.000,00 int. ver. R.E.A. 227083
Reg. Imp. RE/CEE Code/P.IVA (IT) 01829970357
Via Cav. del Lavoro Adelmo Lombardini, 2
42124 Reggio Emilia - Italia
Tel. +39.0522.3891 - Fax +39.0522.389503
info@lombardini.it www.lombardini.it

Files for this product available on www.lombardini.it

Data sheet	LDW1603DS.PDF
Owner manual	LDW1603OM.PDF
Service manual	LDW1603SM.PDF
Technical drawing	LDW1603TD.DWG
Power curve	LDW1603PC.PDF

LOMBARDINI RESERVES THE RIGHT TO MAKE MODIFICATIONS WITHOUT PRIOR NOTICE

cod. 35581640 - 11-2009